

<b>BLACK FIN CORP.</b>	
DESCRIPTION: <b>DC. CIRCUIT</b>	
DRAWN: <b>Hedder</b>	FOR: <b>BLACK FIN 32 DISSEL</b>
DATE: <b>4-30-84</b>	<b>843204</b>

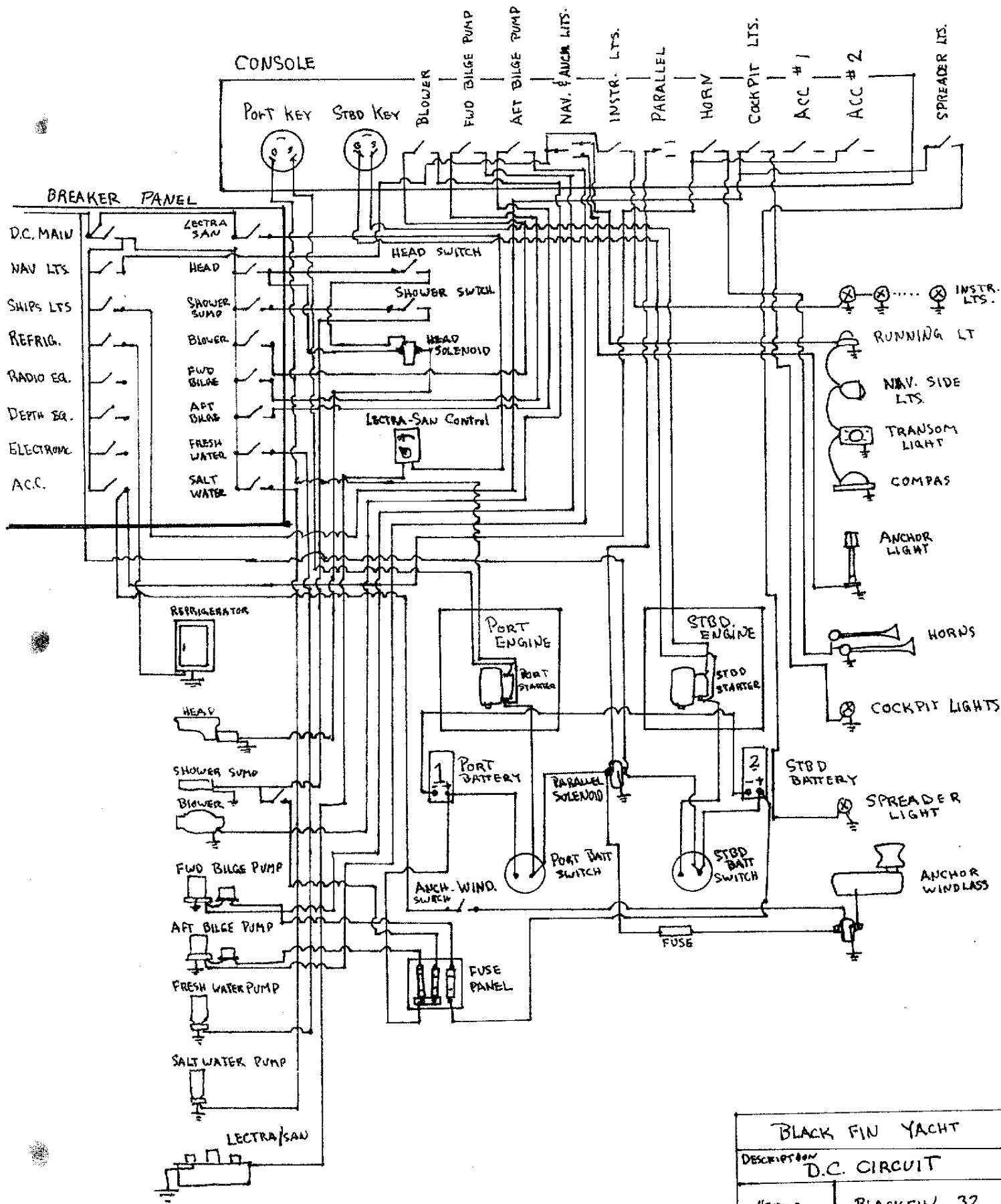

BLACK FIN YACHT	
DESCRIPTION D.C. CIRCUIT	
HECTOR	BLACKFIN 32 GASOLINE
DATE	4-70-84
	# 843205

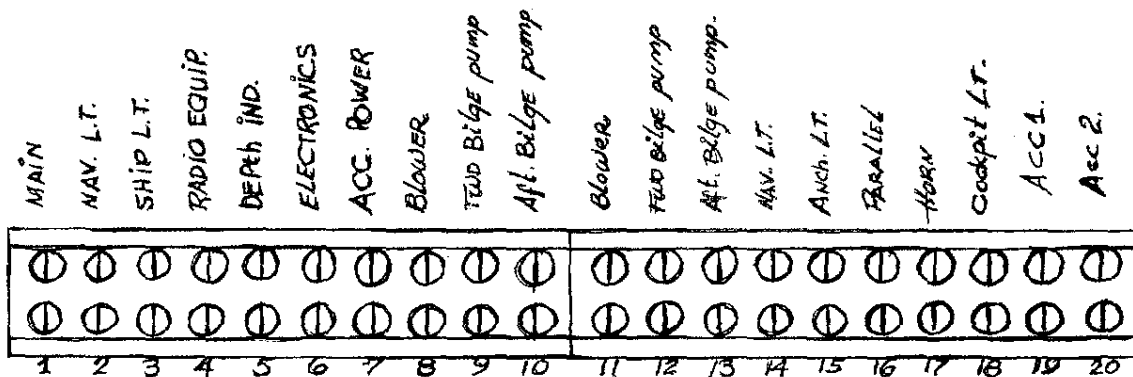

GROUP (A). COME FROM BREAKER PANEL FOR FEED CONSOLE.

GROUP (B). COME FROM CONSOLE SWITCH PANEL TO SHIP.

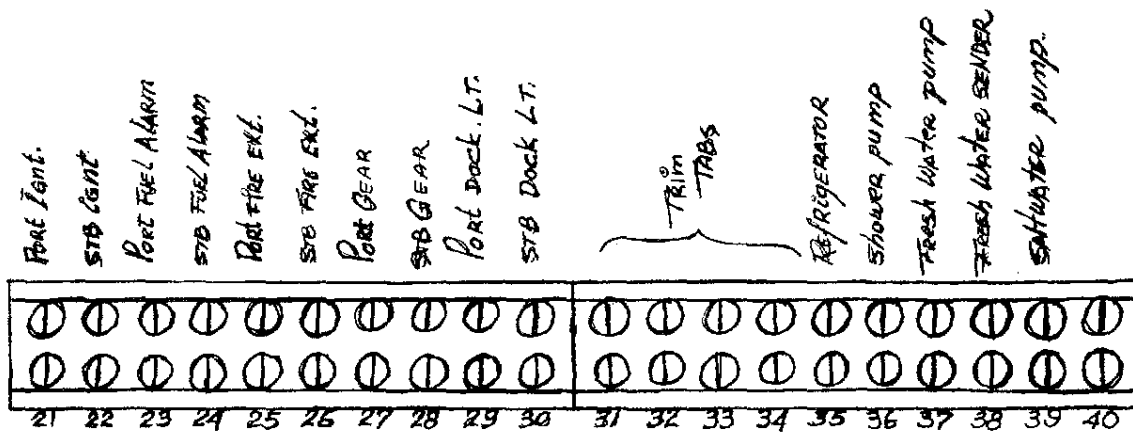

GROUP (C). OPTIONAL EQUIPMENTS, COME FROM CONSOLE TO SHIP.

GROUP (D). COME FROM BREAKER TO SHIP.

NOTE: GROUPS (A), (B) and (D) ARE STANDARDS.

GROUP (C) IS OPTIONAL

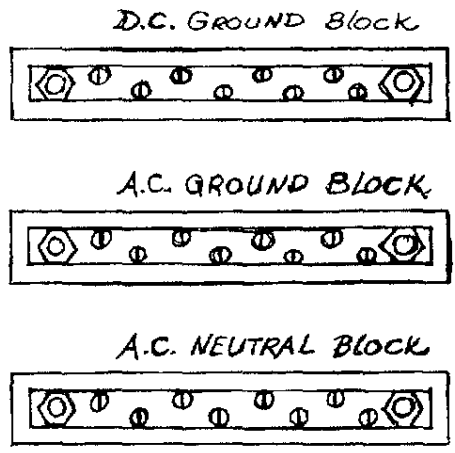
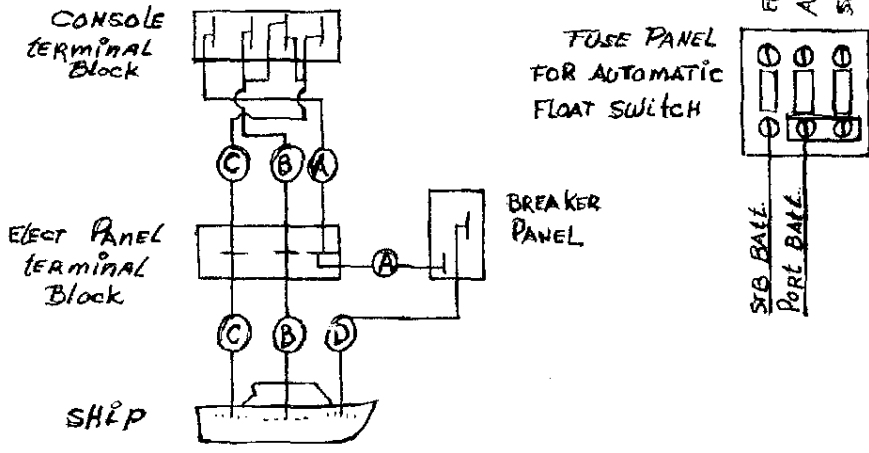

BLACK FIN CORR.	
DESCRIPTION	Terminal blocks
DRAWN BY	FOR BLACK FIN 92 ELECTRICAL PANEL
DATE	843206

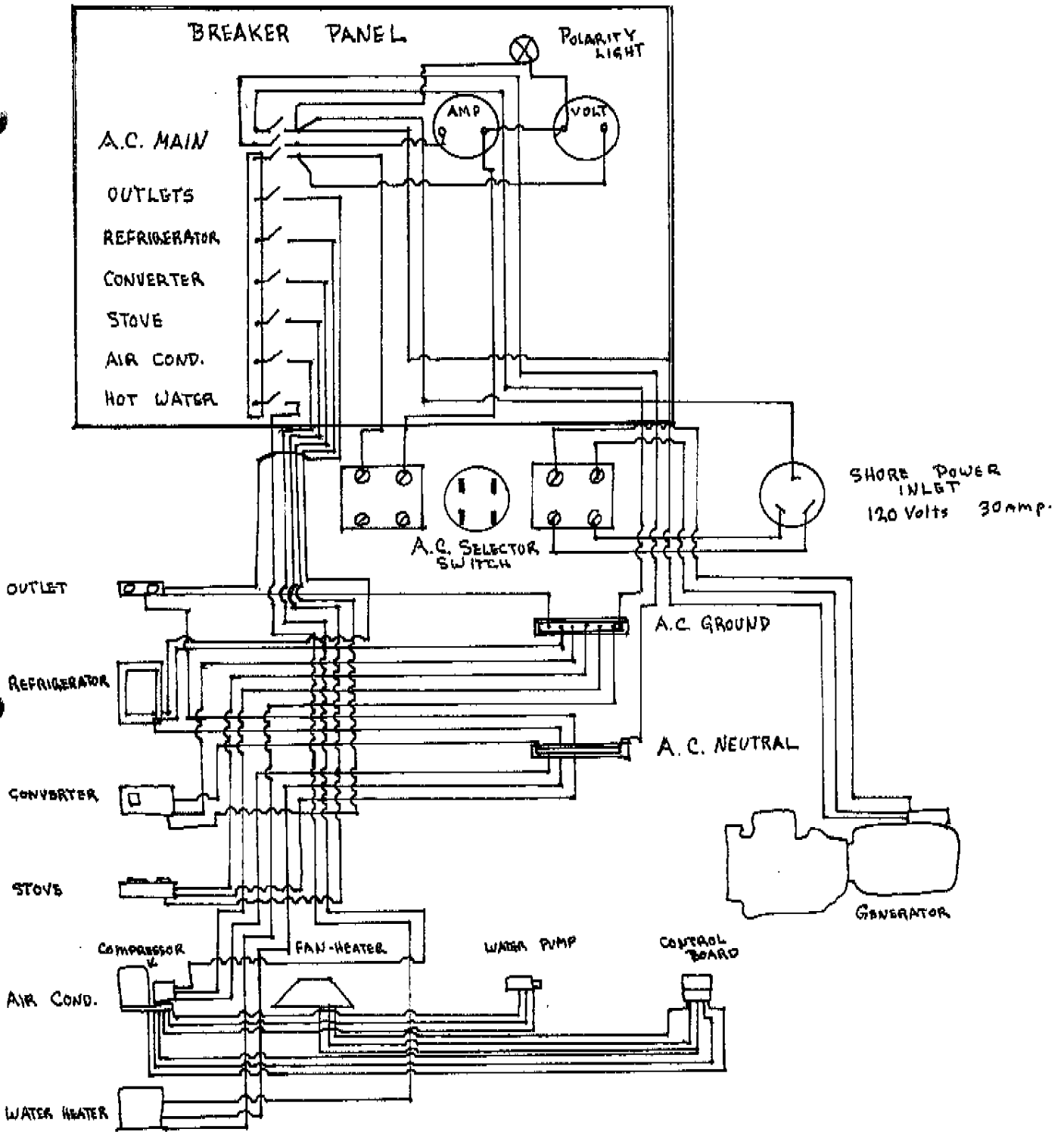

BLACK FIN YACHT	
DESCRIPTION A.C. CIRCUIT	
DRAWN BY HECTOR	BLACKFIN 32
5-14-84	843208

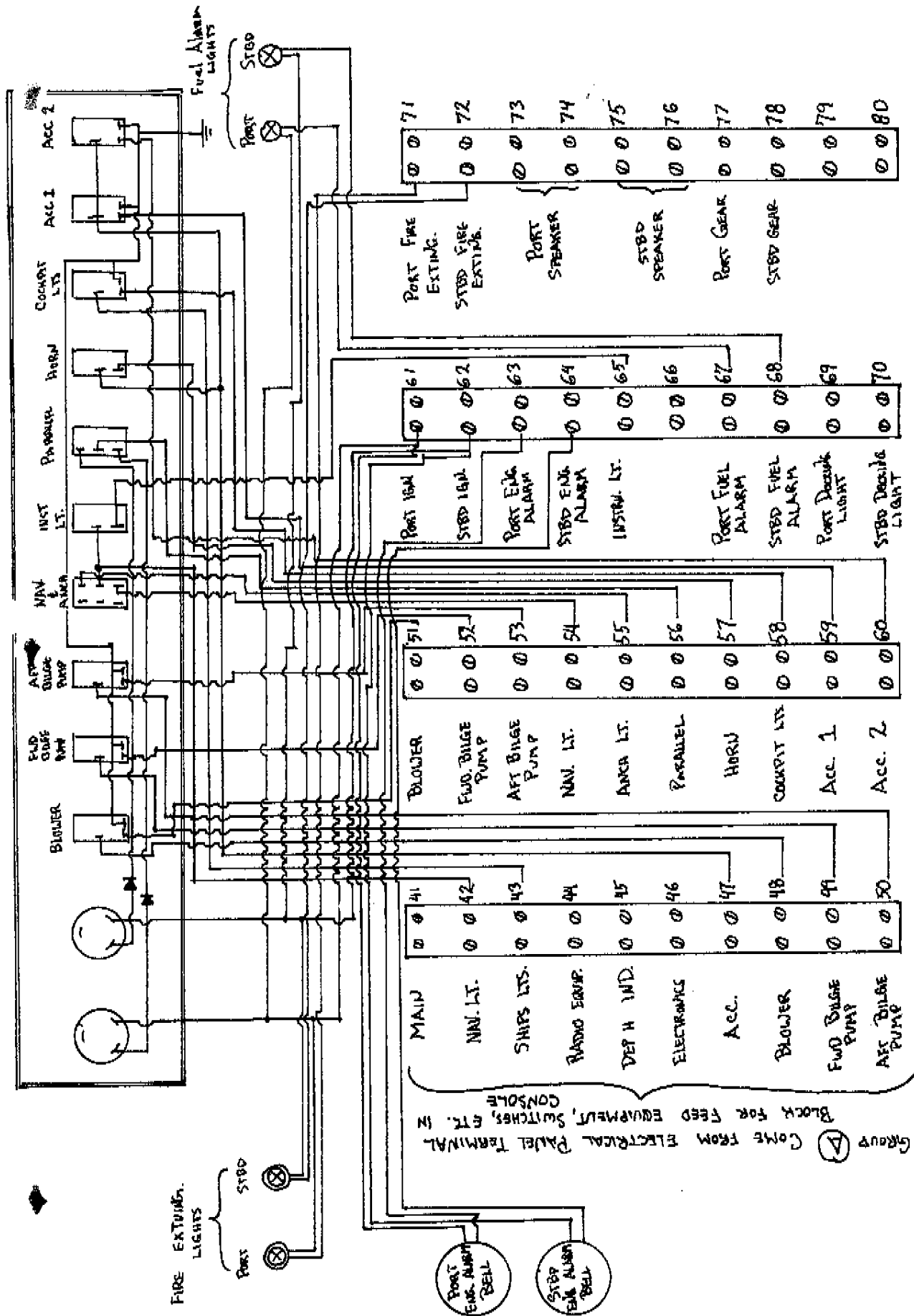

BLACK FIN YACHT	
DESCRIPTION	
PROJECT	ELECTRICAL DIAGRAM
HECTOR	BLACKFIN 32'
DATE	5-21-84
	# 845209